

Monofocal IOLs

Designed to deliver without compromise

Ray One
HYDROPHOBIC
BLF

Ray One
HYDROPHOBIC
ASPHERIC

Ray One
ASPHERIC

Ray One
SPHERIC

Ray One
TORIC

SULCOflex
ASPHERIC

SULCOflex
TORIC

Rayner

Leading the way in ophthalmic innovation

Rayner manufactured the world's first IOL in 1949, and has remained at the forefront of innovation for over 70 years, focused on providing you and your patients with the best IOLs and ophthalmic solutions - always driven by science to improve patient outcomes and safety.

Rayner is the only manufacturer of IOLs in the UK, with its state-of-the-art manufacturing plant and Global Headquarters on the South Coast of England.

1910

Rayner is founded in London, UK.

1949

Rayner makes the world's first IOL.

1979

Rayner has the first IOL approved by the US FDA.

2007

Rayner launches:

- The first multifocal toric IOL
- The first pseudophakic supplementary IOL
- The first FDA approved IOL from a non-American manufacturer in two decades.

2016

- Brand new HQ and state-of-the-art manufacturing facility opens in Worthing, UK.
- RayOne fully preloaded IOL system is unveiled at the 2016 ESCRS congress.
- Rayner acquires Moorfields Pharmaceuticals.

2017

RayOne Trifocal premium preloaded IOL is launched.

2018

- RayOne Hydrophobic and RayOne Toric preloaded IOLs are released.
- Sulcoflex Trifocal, the world's first supplementary trifocal IOL is launched.
- AEON eye drop family is introduced, designed specifically for before and after surgery.

2019

- RayPRO digital platform for patient reported outcomes data is released.
- RayOne Trifocal Toric is launched, completing Rayner's trifocal IOL family.

2020

RayOne EMV premium preloaded IOL is launched.

2021

RayOne Hydrophobic BLF is released, Rayner's first blue light filtering IOL.



Monofocal IOL solutions for all your patients

RayOne - for placement in the capsular bag

When creating RayOne, we developed our MICS lens and unique patented Lock & Roll technology as part of the same design process; this combination has resulted in the smallest fully preloaded injector available (1.65 mm nozzle) for a 2.2 mm incision.

Our hydrophobic and hydrophilic MICS lenses are born out of a desire to deliver a better operating room experience for surgeons and better visual outcomes for patients, by challenging the current IOL solutions available to them.

Sulcoflex - for placement in the ciliary sulcus

As a cataract and refractive surgeon, achieving the best possible visual results for your patients is paramount. But sometimes even the best patient selection and most accurate work can result in a refractive surprise.

Our Sulcoflex supplementary IOLs are designed to be implanted in the ciliary sulcus to correct residual post-operative refractive errors following the implantation of a conventional IOL in the capsular bag.

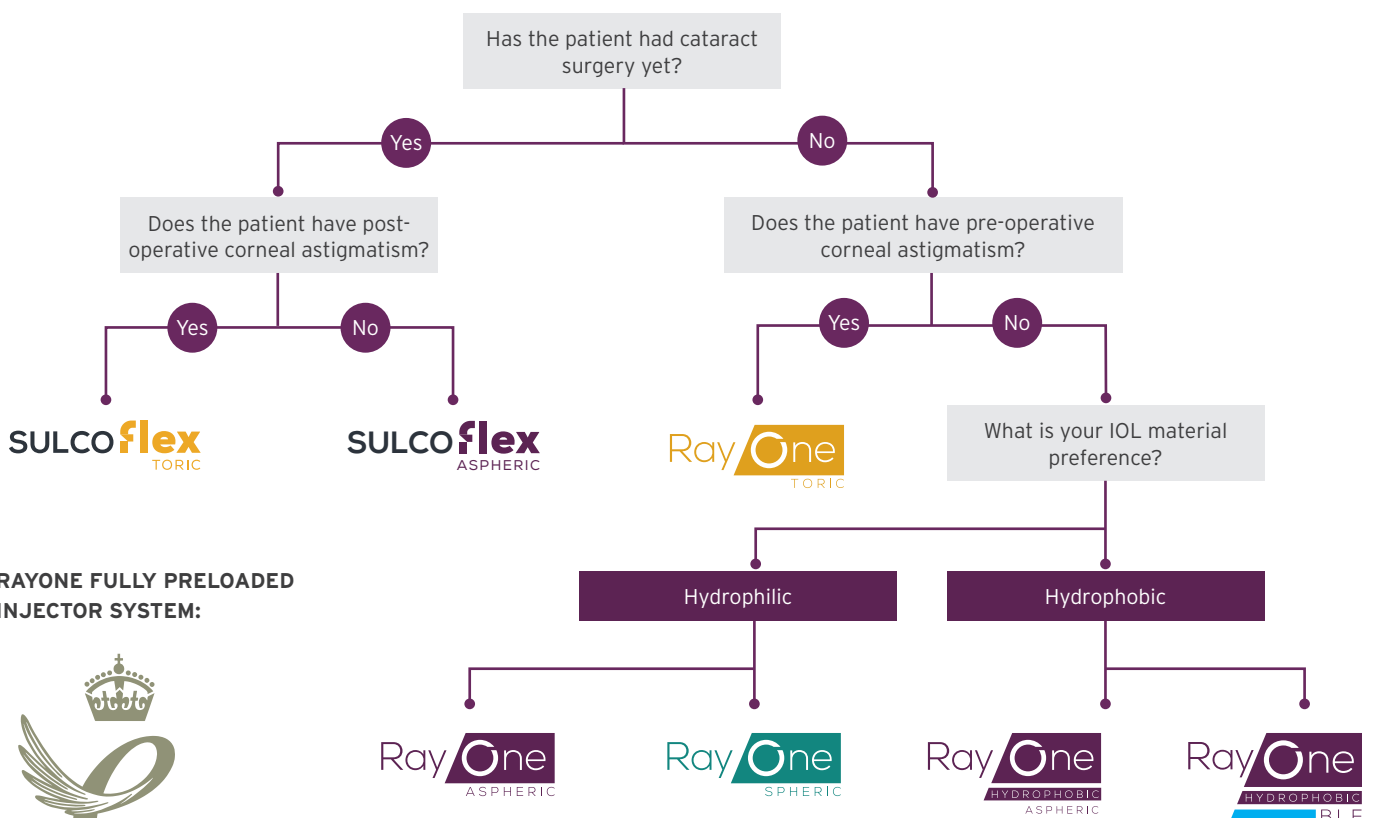

RAYONE FULLY PRELOADED
INJECTOR SYSTEM:



THE QUEEN'S AWARDS
FOR ENTERPRISE:
INNOVATION
2020

RayOne injector

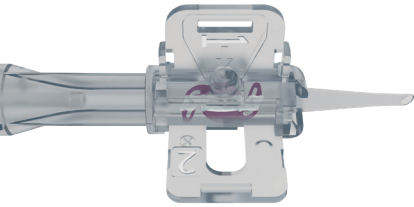

TWO-STEP SYSTEM

- **Step 1:** Insert OVD into cartridge via port
- **Step 2:** Lock cartridge ready for implantation
- Easy to use¹⁵
 - Minimal learning curve
 - Minimises error
- Efficient IOL delivery time¹⁵
 - Designed for repeatability
 - Reduces operating time

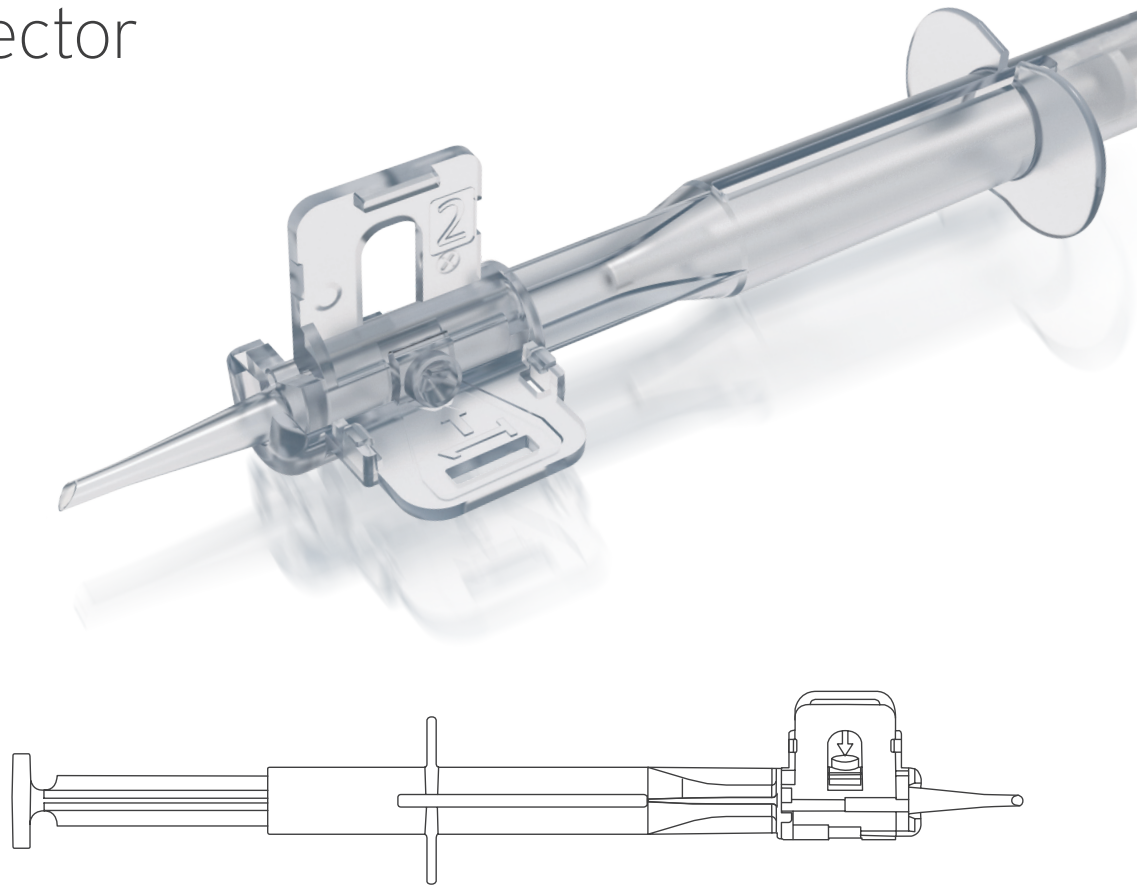

FEATURES & BENEFITS

- 1.65 mm nozzle for 2.2 mm incision
- Smallest fully preloaded injector nozzle
 - Ease of insertion
 - Enables true micro incision
- Parallel sided for minimal stretch
 - 2.2 mm delivery
 - Maintains incision architecture
- Ergonomic design for ease of handling
- Single handed plunger with minimal force required

Unique patented Lock & Roll technology for consistent delivery

- Rolls the lens to under half its size before injection
 - Consistent, smoother delivery
 - Reduces insertion forces
- Fully enclosed cartridge with no lens handling
 - Reduces the risk of lens damage
 - Minimises chance of contamination

Lock & Roll technology



Consistently locked and rolled to under half its size in one simple action

In a comparative study of six market-leading preloaded delivery systems¹⁵

1. RayOne received the maximum score for 'ease of use' for all delivery steps:



2. RayOne was the least time consuming system for delivering the IOL

3. RayOne showed less injector tip damage post-insertion than 50% of the tested delivery systems

4. RayOne showed minimal wound stretch compared to other tested delivery systems when through a 2.2 mm incision



Ultrasert (U) (Alcon Laboratories, Inc.), iTec (IT) (Abbott Medical Optics, Inc.), Eyecee (E) (Bausch & Lomb, Inc.), iSert (IS) (Hoya Surgical Optics, Inc.), and CT Lucia (CT) (Carl Zeiss Meditec AG). All trademarks are property of their respective owners

One injector for all RayOne IOLs

A single fully preloaded and repeatable injector for all RayOne IOLs reduces training for clinic teams and supports surgeon confidence in the operating room.

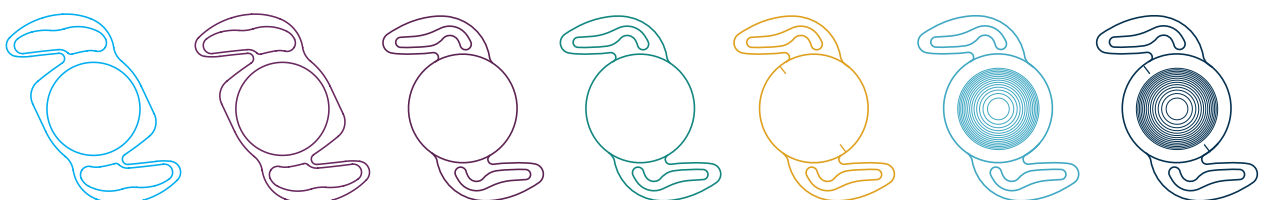

RayOne Hydrophobic / Hydrophobic BLF

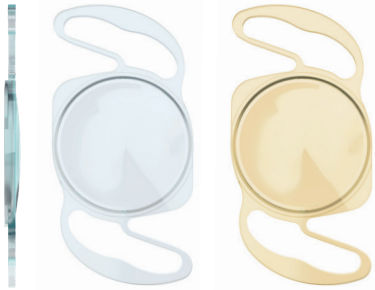

KEY INFORMATION

- Ultra glistening-free
- Ultra smooth delivery
- Ultra stable positioning
- Fully preloaded across the entire power range



FEATURES & BENEFITS

- Aberration-neutral technology for visual quality and acuity in all light conditions.
- Thanks to their Amon-Apple 360° Enhanced Square Edge and natural bioadhesivity, our hydrophobic lenses are designed to minimise the risk of PCO.
- Rayner's anti-vaulting haptics lock against the unique Cornerstone tabs for superb stability
- Our patented Lock & Roll system rolls the lens inside the injector for a single smooth movement into the eye.
- Available with blue light filtering properties.

Cornerstone technology

Our patented Cornerstone lens design ensures the IOL is perfectly balanced as it travels down the injector nozzle. Once in the eye, Rayner's anti-vaulting haptics lock against the unique Cornerstone tabs for superb stability.

In the eye

Combining the Cornerstone tabs with our anti-vaulting haptic technology creates superb stability once inside the capsular bag.



Designed for a better experience than current hydrophobic IOLs

Unwilling to accept the compromises inherent with many hydrophobic lenses, RayOne Hydrophobic and RayOne Hydrophobic BLF are designed to provide patients with the visual outcomes they demand in a high performing preloaded system that supports surgeons in the operating room.

Fully preloaded power range

Only one IOL solution is needed for all your monofocal patients.

- RayOne Hydrophobic -10.0 D to +32.0 D
- RayOne Hydrophobic BLF +0.0 D to +32.0 D

Always ready to implant

Our proprietary material is not dependent on the temperature within the operating theatre, so it arrives ready-to-use with no warming or waiting needed.

Improved performance and quality

All hydrophobic acrylic IOLs absorb water once *in situ* within the eye, causing expansion in size. Our lenses are supplied in 0.9% saline solution so that they are in an equilibrated state and dimensionally stable from manufacture to implantation - reducing the chance of undesirable post-implant lens movement.

RayOne Hydrophobic

Superb stability in the eye:

- ✓ Unique lens design combines our Cornerstone shape with anti-vaulting haptics for stability from the nozzle and into the eye
- ✓ Dimensionally stable

Optimised visual qualities:

- ✓ Ultra glistening-free
- ✓ Aspheric, aberration-neutral design
- ✓ UV protection

Minimised risk of complications:

- ✓ 2.2 mm incision via 1.65 mm injector nozzle
- ✓ Designed to minimise PCO due to Amon-Apple 360° Enhanced Square Edge

Easy to use and manage:

- ✓ Fully preloaded, true 2-step injector system with patented Lock & Roll technology
- ✓ Proprietary hydrophobic material with no warming or waiting required
- ✓ Full power range (-10.0 D to +32.0 D) means only one monofocal solution for all your patients

RayOne Hydrophobic BLF

NEW

All the benefits of our RayOne Hydrophobic fully preloaded aspheric monofocal IOL, also available with a blue light filter.

RayOne Hydrophobic BLF is designed to provide patients with good functional vision following cataract removal with the additional benefit of blue light filtering properties.

- ✓ A small amount of blue light is still transmitted through the lens in order to stimulate the natural circadian rhythm for a healthy sleep-wake cycle.
- ✓ Could help to protect patients' retinas from potentially harmful blue light.
- ✓ Simulates the natural crystalline lens.
- ✓ May be useful in reducing the risk of Age-related Macular Degeneration (AMD) in pseudophakic eyes.



RayOne Hydrophobic / Hydrophobic BLF

LENS DELIVERY

As hydrophobic lenses are made of a naturally stiffer material than their hydrophilic counterparts, they are typically more difficult to compress and fold inside the injector.

If the IOL is not folded symmetrically then it can exit the injector nozzle unpredictably - for example, in the undesired 'S' position.

Our Cornerstone tabs balance the volume of material on both sides of the lens - resulting in:

- Balanced weighting inside the injector
- Controlled haptic orientation
- Controlled speed of exit

HOW IT WORKS

Our Lock & Roll system rolls the hydrophobic lens with improved symmetry, meaning that it travels down the injector nozzle in a more stable and predictable manner, with a controlled exit into a 'Z' orientation.

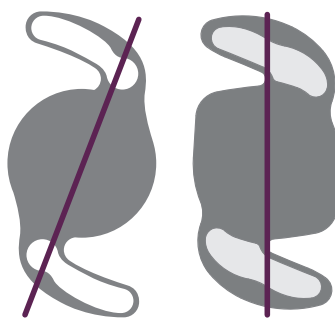

Traditional lens design

RayOne Hydrophobic

All trademarks are property of their respective owners

The difference with RayOne Hydrophobic

Glistenings are fluid-filled microvacuoles that form within the matrix of the lens when exposed to an aqueous environment. High levels of glistenings can create disturbances for patients, with the scattering of light impacting their contrast sensitivity and unnecessarily compromising their post-surgery satisfaction.

Independent comparative study

Following an established protocol, RayOne Hydrophobic was tested against four commercially available hydrophobic IOLs. Five IOLs of each model were subjected to an in-vitro aging procedure designed to simulate clinical conditions over time, with the resultant level of glistenings in each IOL material evaluated.

The images below are from an independent study conducted at the University Hospital Heidelberg in Germany. They show the results after glistening induction at 14x magnification.

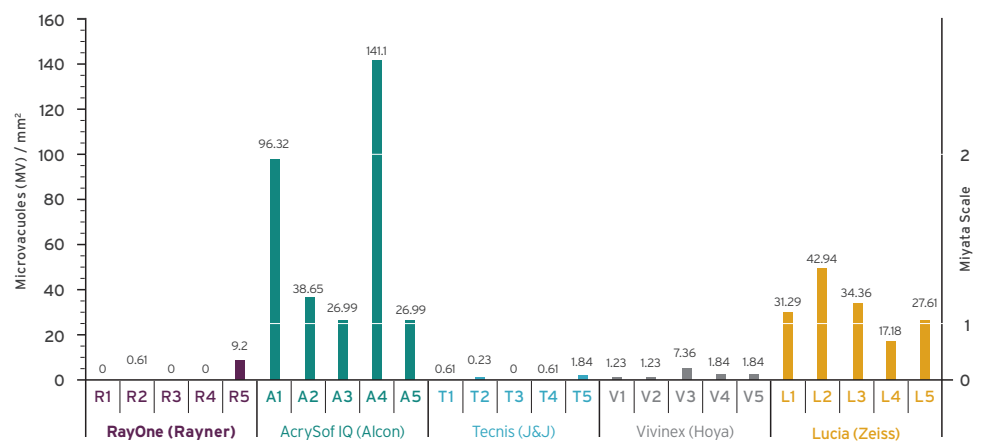
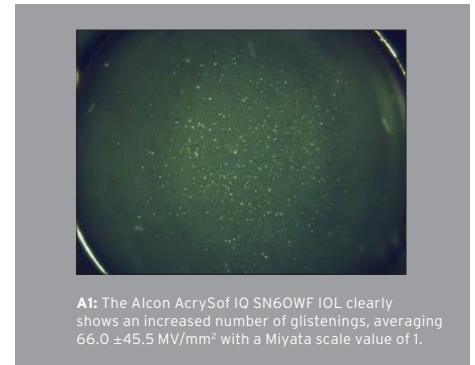
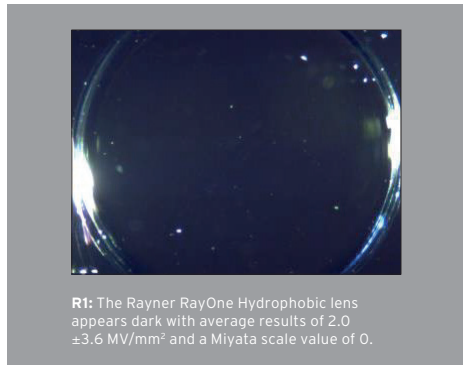

RayOne Hydrophobic reached 'significantly lower mean glistening numbers' compared to the AcrySof IQ (Alcon) and Lucia (Zeiss) IOLs ($P < 0.05$).¹ A score below one on the clinical Miyata scale will not produce any significant visible glistenings on a slit lamp examination and is considered 'glistening-free'.

The independent study report concludes that RayOne Hydrophobic shows 'high resistance to microvacuole formation' and is equivalent or superior to the best hydrophobic IOLs currently available on the market.¹

Note: 'Glistening free' is partially supported through an experimental laboratory study. Clinical data to support the claim is not yet available.

Clinical outcomes

Dr. Kevin Waltz, Dr. Gabriel Quesada and Dr. Marco Robles performed the World's first RayOne Hydrophobic implantations in El Salvador, Central America.

Extract from article in Cataract & Refractive Surgery Today Europe (Nov/Dec 2018 Edition):

Before this series of hydrophobic IOL implantations, all three of us had used the preloaded Rayner RayOne Aspheric hydrophilic IOL and injector to establish a comparative baseline and gain a feel for the system. The hydrophobic IOL and injector system's performance was similar, if not identical, to that of the hydrophilic platform in terms of ease of insertion and refractive predictability.

A total of 50 eyes were implanted over the course of one week in El Salvador. Average patient age was 73 years. The cataracts we encountered, in general, were quite dense (20/200 or worse preoperative visual acuity), often with small pupils that created a challenging surgical environment. The RayOne Hydrophobic IOL and injector platform

performed well in this environment, achieving reliable insertion of the IOL into the capsular bag, even through small pupils.

The data [collected postoperatively] demonstrated predictable, stable refraction and visual acuity over the first three months after implantation. Four eyes were excluded from final data analysis due to macular pathology that was not identified preoperatively due to dense cataract.

The Cornerstone lens shape was developed to improve the consistency of the planar delivery of the IOL. It improves the stability of the IOL as it transits the injector cartridge, ensuring consistent delivery into the capsular bag.

The RayOne Hydrophobic was safe and reliable in this small series with limited follow up. Refractive outcomes were excellent, reflecting stable and predictable effective lens position. There was no variation of visual acuity over the three months of data collection. All surgeons found the IOL easy to use with good stability and centration in all cases.

Postoperative Manifest Refraction and Visual Acuity

No. Eyes	Follow-up visit	SE ± SD	Sphere ± SD	Cylinder ± SD	LogMAR VA
46	Month 1	+0.25 ± 0.60	+0.72 ± 0.18	+0.94 ± 0.53	+0.05 ± 0.08
46	Month 3	+0.17 ± 0.55	+0.69 ± 0.53	+1.04 ± 0.53	+0.06 ± 0.10

Abbreviations: No. = number; SE = spherical equivalent; SD = standard deviation; VA = visual acuity

Professor Thomas Kohnen, Chair of the Department of Ophthalmology Goethe University, Frankfurt, Germany implanted the World's first RayOne Hydrophobic IOL post-CE mark in May 2018.

Summary of Professor Kohnen's presentation at the 2018 ESCRS congress in Vienna:

Professor Kohnen commented on the surgery "nice to see in the first implantation there was very smooth delivery of the IOL into the capsular bag" and with regards to the Cornerstone technology he stated this "gives better stability to the IOL. From my perspective, a very nice implantation, very easy to do and very much in the standards of the current monofocals."

Professor Kohnen described the injector system as "simple and intuitive with minimal learning curve", and when

addressing the complete power range of -10.0 D to +32.0 D he stated "this is a very smart move, because if you go into the myopic range, then you can really cover the whole range, many companies unfortunately stop at +10.0 D or +6.0 D."

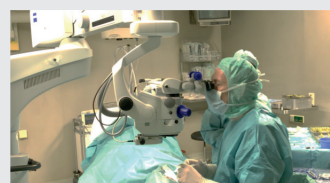

Professor Kohnen implanting the first RayOne Hydrophobic.



RayOne Hydrophobic centred in the capsular bag.

RayOne Aspheric / Spheric / Toric

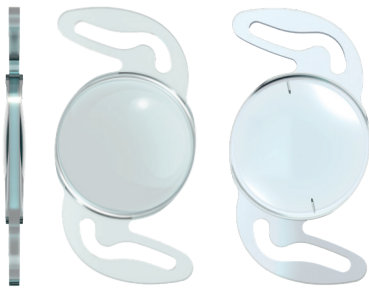

HYDROPHILIC
MATERIAL

KEY INFORMATION

- Amon-Apple enhanced square edge for minimal PCO 1.7% at 24 months²
- Average offset of only 0.08 mm 3 to 6 months after surgery³
- 1.83° mean IOL rotation 3 to 6 months after surgery³

FEATURES & BENEFITS

Available as:

- Spheric
- Aberration-neutral aspheric
- Aberration-neutral aspheric toric

- RayOne Toric is available in an extensive range of sphere and cylinder powers, allowing you to accurately correct more of your patients, even those with significant corneal astigmatism.

Largest fully preloaded power range on the market - one solution for all your patients:

- Aspheric & Spheric
-10.0 D to +34.0 D sphere
- Toric: -9.5 D to +34.5 D SE,
+1.0 D to +11.0 D cylinder

*Of those who expressed a preference

When considering an intraocular lens, what's important to you?

RayOne Aspheric and RayOne Toric are designed with an aspheric anterior surface that creates no spherical aberration.

Studies have demonstrated that aberration-neutral technology:

- Offers improved contrast sensitivity compared with spherical IOLs^{4,5}
- Provides better low light level visual acuity than spherical IOLs⁶
- Can offer more depth of field than aberration-negative IOLs by retention of the patient's natural level of corneal spherical aberration⁷
- Are less susceptible to the effects of decentration than aberration-negative IOLs⁸
- Twice as many patients* preferred the aberration-neutral IOL than aberration-negative⁷
- Three times fewer reports of visual disturbances with the aberration-neutral IOL than aberration-negative⁷

Reducing dysphotopsia by design

- Rayner's Enhanced Square Edge Technology shows no general increase in glare from previous models without a square edge²
- Low refractive index (1.46)

VACUOLE FREE MATERIAL FOR A GLISTENING FREE IOL

- Single piece IOL created from a homogeneous material free of microvacuoles⁹
- Compressible material for delivery through a micro incision
- Excellent handling characteristics with controlled unfolding within the capsular bag
- Low silicone oil adherence¹⁰
- Excellent uveal biocompatibility¹¹
- Hydrophilic acrylic material with low inflammatory response¹²

HOW MANY OF YOUR PATIENTS WOULD BENEFIT FROM A RAYONE TORIC IOL?

Prevalence of pre-operative corneal astigmatism in a cross-sectional study of 746 patients (1,230 eyes):¹³

Over 40%
presented with >1.0 D of astigmatism

More than 20%
presented with >1.5 D of astigmatism

360° Optimised Barrier to reduce PCO

Rayner's 360° Amon-Apple Enhanced Square Edge creates an optimum barrier to reduce epithelial cell migration including at the haptic-optic junction.^{2,14}

ND: YAG CAPSULOTOMY RATES ²		MEAN TIME TO ND: YAG CAPSULOTOMY ²
At 12 months	0.6%	9.3 ± 5.5 mths (range 2.6 - 22.7 mths)
At 24 months	1.7%	Follow-up period: 5.3 - 29 mths

Extremely low Nd:YAG capsulotomy rates, comparable with hydrophobic acrylic lenses with square-edge optics.²

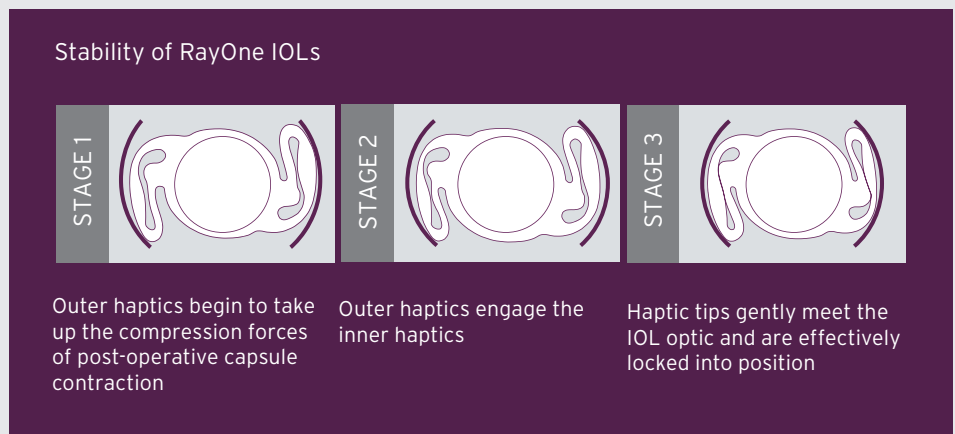

Proven rotational stability and centration with predictable, sustainable and accurate visual results

Just one degree of misalignment results in about 3.5% loss of cylindrical correction, two degrees up to about 7%, and 10 degrees more than 34%.

In a prospective study in 66 eyes³:

1.83° +/- 1.44° rotation 3 to 6 months after surgery

0.08 +/- 0.37mm decentration 3 to 6 months after surgery

Sulcoflex Aspheric / Toric

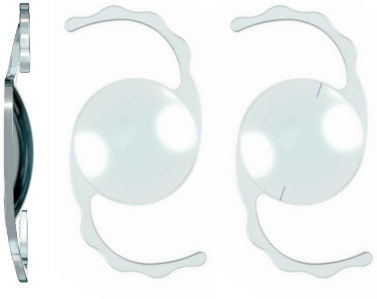

HYDROPHILIC
MATERIAL

KEY INFORMATION

- Safe, predictable and effective at improving uncorrected Visual Acuity¹⁶
- Enhances post-operative refractive results^{16,23,24}
- Aspheric available in -10.0 D to +10.0 D (0.5 D increments)

FEATURES & BENEFITS

Large 6.5 mm round-edged optic, designed to:

- Reduce the risk of pupillary block and photic effects
- Reduce risk of optic-iris capture¹⁸
- Minimise edge glare and associated dysphotopsia¹⁸

Large 14.0 mm overall length:

- Smooth undulating haptics to minimise the risk of adverse tissue reaction in the ciliary sulcus, with 10° angulation
- Excellent centration stability compared to capsular bag fixated IOLs²⁰
- Reduced risk of uveal contact and abrasion¹⁸

Designed to avoid the potential problems of conventional 'piggy-back' IOLs^{18,21,22}

- Unique posterior concave surface, minimises the possibility of interaction with the primary IOL
- Reduced likelihood of unwanted photopic effects
- Reduced refractive error with hyperopic defocus



Physical contact between the two IOLs minimised.

Iris - Sulcoflex



Sulcoflex - IOL

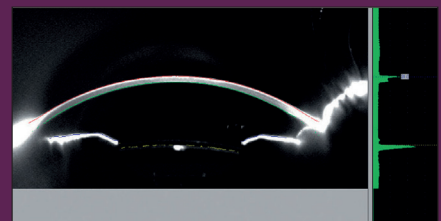

An elegant solution for treating refractive surprise - over 12 years of patient data.

Sulcoflex pseudophakic supplementary IOLs are designed to be implanted in the ciliary sulcus to correct residual post-operative refractive errors following the implantation of a conventional IOL in the capsular bag.

The Sulcoflex lens has been demonstrated to be safe, predictable and effective at improving uncorrected Visual Acuity¹⁶ and enhances post-operative refractive results^{16,23,24} with no significant intra- or post-operative complications.²⁴

With the Rayner Sulcoflex platform, you can expect the following:

- Ease of use¹⁹
- Efficacy and patient outcomes¹⁹
- An adjustable solution for peace of mind
- Low capital expenditure
- Designed to avoid the potential problems of conventional "piggy-back" IOLs^{18,21,22}

Predictability^{16,18,20}

- Lack of tilt or decentration
- Predictable refractive outcomes with high visual acuity

High patient satisfaction^{19,25}

- Low complication rate
- Stable long-term refractive results

Reduced surgical risk associated with IOL exchange^{17,18,21}

- Less surgical trauma than primary IOL exchange
- Avoids sometimes difficult removal of fibrosed, fixated primary implant
- Allows for implantation reversibility



"Implantation of the Sulcoflex is safe, easy and it is less traumatic than IOL exchange."

Professor Michael Amon MD, Head of the Department of Ophthalmology at the Academic Teaching Hospital of St John, Vienna, Austria

OPTIC & MATERIAL

Aberration-neutral Aspheric Optics:

- Improved contrast sensitivity and functional visual acuity*

Rayacryl material for:

- Good uveal Biocompatibility⁹
- Superb optical clarity - no vacuoles or glistenings¹¹

* When compared to spherical optics

Injector

Sulcoflex Aspheric and Sulcoflex Toric are fully compatible with the Medical Accuject 1.8 single use injector.



Model Name	RayOne Aspheric RAO600C RayOne Spheric RAO100C	RayOne Toric RAO610T	RayOne Hydrophobic Aspheric RAO800C	RayOne Hydrophobic Aspheric BLF RAO850B
Power Range	-10.0 to +7.0 D (1.0 D increments, inc. plano) +8.0 to +30.0 D (0.5 D increments) +31.0 to +34.0 D (1.0 D increments)	Standard SE +8.0 to +30.0 D (0.5 D increments) Cylinders +1.0 to +6.0 D (0.5 D increments) Made to order SE -9.5 to +34.5 D (0.5 D increments) Cylinders +1.0 to +11.0 D (0.5 D increments) Availability is subject to power combination	-10.0 D to +7.0 D (1.0 D increments, inc. Plano) +8.0 D to +30.0 D (0.5 D increments) +31.0 D to +32.0 D (1.0 D increments)	+0.0 D to +7.0 D (1.0 D increments) +8.0 D to +30.0 D (0.5 D increments) +31.0 D to +32.0 D (1.0 D increments)

Monofocal IOLs	RayOne Aspheric, RayOne Spheric & RayOne Toric	RayOne Hydrophobic & RayOne Hydrophobic BLF
Material	Single piece Rayacryl hydrophilic acrylic	RayOne Hydrophobic Aspheric: Single piece Rayner hydrophobic acrylic RayOne Hydrophobic Aspheric BLF: Single piece Rayner hydrophobic acrylic with blue light filtering chromophore
Water Content	26% in equilibrium	<3%
UV Light Transmission	UV 10% cut-off is 380 nm	UV 10% cut-off is 385 nm
Refractive Index	1.46	1.51
ABBE	56	43
Overall Diameter	12.5 mm	
Optic Diameter	6 mm	
Optic Shape	RayOne Aspheric & RayOne Spheric: Biconvex (positive powers), Biconcave (negative powers) RayOne Toric: Biconvex (positive powers), Convex/Concave posterior surface (negative powers)	Biconvex (positive powers), Plano, concave (negative powers)
Asphericity	RayOne Aspheric: Anterior aspheric surface with aberration-neutral technology RayOne Toric: Posterior aspheric surface with aberration-neutral technology	Posterior aspheric surface with aberration-neutral technology
Optic Edge Design	Amon-Apple 360° enhanced square edge	
Haptics	0° Angulation, uniplanar. Anti-Vaulting Haptic (AVH) technology	Cornerstone lens design with Anti-Vaulting Haptic (AVH) technology

Delivery System

Injector Type	Single use, fully preloaded IOL injection system
Incision Size	1.65 mm nozzle for 2.2 mm incision
Bevel Angle	45°
Lens Delivery	Single handed plunger

Estimated Constants for Optical Biometry

	SRK/T	Haigis			HofferQ	Holladay	Holladay II	Barrett Universal II	
	A-constant	a0	a1	a2	pACD	SF	pACD	LF	DF
Aspheric, Spheric, Hydrophobic & Hydrophobic BLF	118.6	1.17	0.40	0.10	5.32	1.56	5.32	1.67	0
Toric	118.6	1.17	0.40	0.10	5.32	1.56	5.32	1.67	4 (SE)

For Contact Ultrasound, the estimated A-constant for Hydrophobic, Hydrophobic BLF, Aspheric, Spheric and Toric is 118.0. Please note that the constants indicated for all Rayner lenses are estimates and are for guidance purposes only. Surgeons must always expect to personalise their own constants based on initial patient outcomes, with further personalisation as the number of eyes increases.

Model Name	Sulcoflex Aspheric IOL700L	Sulcoflex Toric IOL710T
Power Range	Standard -5.0 D to -0.5 D (0.5 D increments) +0.5 D to + 5.0 D (0.5 D increments) Made to order -10.0 D to -5.5 D (0.5 D increments) +5.5 D to + 10.0 D (0.5 D increments)	Standard Spherical Equivalent: -3.0 D to +3.0 D (0.5 D increments) Cylinders: +1.0 D, +2.0 D, +3.0 D Made to order Spherical Equivalent: -7.0 D to +7.0 D (0.5 D increments) Cylinders: +1.0 D to +6.0 D (0.5 D increments)

Sulcoflex IOLs	
Material	Single piece Rayacryl hydrophilic acrylic
Water Content	26% in equilibrium
UV Protection	Benzophenone UV absorbing agent
UV Light Transmission	UV 10% cut-off is 380 nm
Refractive Index	1.46
ABBE	56
Overall Diameter	14 mm
Optic Diameter	6.5 mm
Optic Shape	Anterior convex, posterior concave
Asphericity	Aberration-neutral technology
Haptic Angulation	10°
Haptic Style	Undulating and rounded C-loop haptics
Estimated constant for power calc.	Expected lens position 4.5 mm

Sulcoflex delivery system	
Injector Type	Medicel ACCUJECT 1.80-1 (LP604540)
Incision Size	1.8 mm nozzle for 2.2 mm incision
Bevel Angle	35°
Lens Delivery	Single handed plunger

For toric and supplementary lens calculations,
visit www.raytrace.rayner.com

RayOne References:

- Yildirim TM et al (2021) Quantitative evaluation of microvacuole formation in five intraocular lens models made of different hydrophobic materials. PLoS ONE 16(4): e0250860.
- Mathew RG, Coombes AGA. Ophthalmic Surg Lasers Imaging. 2010 Nov-Dec; 41(6):651-5. 3. Bhogal-Bhamra GK, Sheppard AL, Kolli S, Wolffsohn JS. J Refract Surg. 2019;35(1):48-53.
- Nanavaty MA, Spalton DJ, Boyce J, Saha S, Marshall J. J Cataract Refract Surg. 2009; 35:663-671. 5. Yagci R, Uzun F, Acer S, Hepsen IF. Eur J Ophthalmol. 2014 Jul 24; 24(5):688-92. 6. Pepose JS, Qazi MA, Edwards KH, Sanderson JP, Sarver EJ. Graefe's Archive for Clinical and Experimental Ophthalmology July 2009, Vol 247, Issue 7, pp 965-973. 7. Johansson B, Sundelin S, Wikberg-Matsson A, Unsbo P, Behndig A. J Cataract Refract Surg. 2007; 33:1565-1572. 8. Altmann GE, Nichamin LD, Lane SS, Pepose JS. J Cataract Refract Surg. 2005; 31(3): 574-585. 9. Rayner. Data on File (RDTR 1937). 10. McLoone E, Mahon G, Archer D, Best R. Br J Ophthalmol. 2001; 85:543-545. 11. Tomlins PJ, Sivaraj RR, Rauz S, Denniston AK, Murray PI. J Cataract Refract Surg. 2014; 40:618-625. 12. Rayner. Data on File. 13. Khan MI, Muhtaseb M. J Cataract Refract Surg 2011; 37:1751-1755. 14. Vyas AV, Narendran R, Bacon PJ, Apple DJ. J Cataract Refract Surg 2007; 33:81-87. 15. Nanavaty MA and Kubrak-Kisza M. J Cataract Refract Surg 2017; 43:558-563.

Sulcoflex References:

- Venter. et al. Piggyback Intraocular Lens Implantation to correct Pseudophakic Refractive Error after segmental multifocal intraocular lens Implantation. J Refract Surg; 30(4): 234-9. 17. Amon MI et al. Enhancing pseudophakic vision with the Rayner Sulcoflex lens. ESCRS Euro Times Supple. 2012:2-3. 18. Amon MI. Correcting refractive surprises following cataract surgery. Cataract Refract Surg Today Europe. 2009:56-9. 19. Khan, M.I. & Muhtaseb, M. Piggybacking with the Sulcoflex. J Cataract Refract Surg. 2010; 36:14-6. 20. Prager F et al. Capsular bag-fixated and ciliary sulcus-fixated intraocular lens centration after supplementary intraocular lens implantation in the same eye. J Cataract Refract Surg. 2017; 43(5):643-647. 21. Kahraman G, Amon M, Vienna, Austria. New Supplementary intraocular lens for refractive enhancement in pseudophakic patients. J Cataract Refract Surg. 2010 Jul; 36(7):1090-4. 22. Manzouri B et al. Supplementary IOLs: Monofocal and Multifocal, Their Applications and Limitations. Asia- Pacific Journal of Ophthalmology. Vol 6, Number 4, July/August 2017. 23. Schrecker J, Blass S, Langenbacher A. Silicone-diffractive versus acrylic-refractive supplementary IOLs: visual performance and manual handling. J Refract Surg. 2014 Jan;30(1):41-8. 24. Falzon KI, Stewart OG. Correction of undesirable pseudophakic refractive error with the Sulcoflex intraocular lens. J Refract Surg. 2012 Sep;28(9):614-9. doi:10.3928/1081597X-20120809-01. 25. Claoué et al. Sulcoflex Pseudophakic Supplementary IOLs. CRST Europe Supplement. 2009. 26. Tomlins PJ et al. Long-term biocompatibility and visual outcomes of a hydrophilic acrylic intraocular lens in patients with uveitis. J Cataract Refract Surg. 2014; 40:618-625.

Support the best visual outcomes with...

AEON

An eye drop family designed specifically to support visual outcomes and patient satisfaction before and after surgery.



rayner.com/aeon

RayPRO

A free mobile and web-based digital platform that collects insightful Patient Reported Outcomes (PROs) over three years.

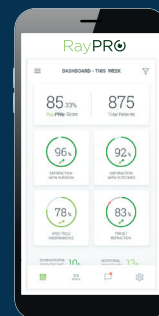

rayner.com/raypro



©2021. Rayner, RayOne, Sulcoflex, AEON, RayPRO and Rayacryl are proprietary marks of Rayner. All other trademarks are property of their respective owners. Rayner Intraocular Lenses Limited, 10 Dominion Way, Worthing, West Sussex, BN14 8AQ. Registered in England: 615539. EC 2021-59 08/21

MADE IN UK

